

KB 6.5 Mounting Block

- Circular clamping
- Robust casing
- Easy-to-install
- Simple installation

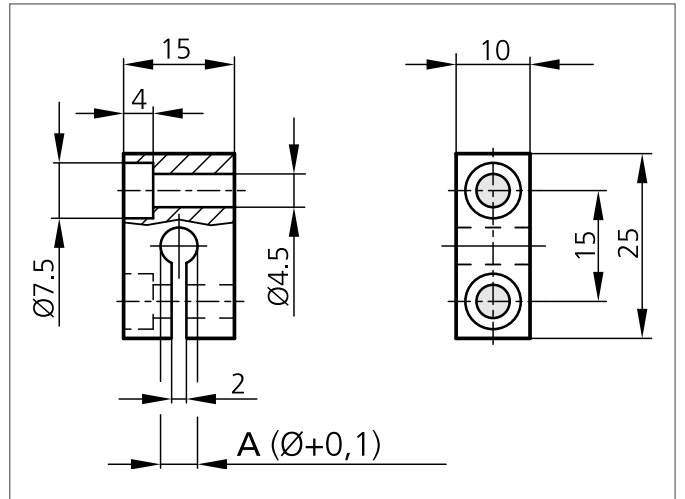

TECHNICAL INFORMATION (typ.)

Hole spacing	15 mm
Mounting	hole, Locking screw
Size	15 x 10 x 25 mm (Dimensions) 6,5 mm (Clamping diameter A)
Design	cuboid design
Casing material	Aluminium black anodized